

Smart Signage User Manual (By Model)

This manual provides information about your Smart Signage including supported types and product specifications per model.

OH85N OH85N-DK

The colour and the appearance may differ depending on the product, and the content in the manual is subject to change without prior notice to improve the performance.

An administration fee may be charged in the following situations:

- (a) An engineer is called out at your request, but it is found that the product has no defect (i.e., where the user manual has not been read).
- (b) You bring the unit to a repair centre, but it is found that the product has no defect (i.e., where the user manual has not been read).

You will be informed of the administration fee amount before a technician visits.

Table of contents

Preparations

Checking the Components	3
Parts	4
Ports	5
OH85N	5
OH85N-DK	6
Before Installing the Product (Installation Guide)	7
Rotation	7
Ventilation	7
Before connecting cables	8
Power cable connection guide	10
Wall Mount Specifications	13

Specifications

General	14
Preset Timing Modes	15

Appendix

Licence	17
---------	----

Chapter 01

Preparations

Checking the Components

 Contact the vendor where you purchased the product if any components are missing.

 The appearance of the components may differ from the images shown.

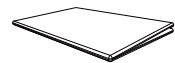

Quick Setup Guide



Warranty card
(Not available in some locations)



Regulatory guide

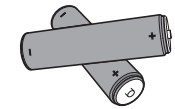

Batteries (AAA x 2)
(Not available in some locations)



Remote Control

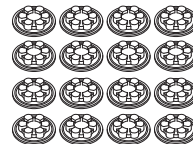

Cover-Cap x 16
(Supported model: OH85N)

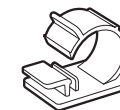

Clasper x 6
(Supported model: OH85N-DK)

Parts

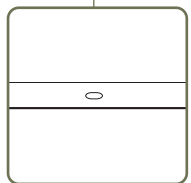
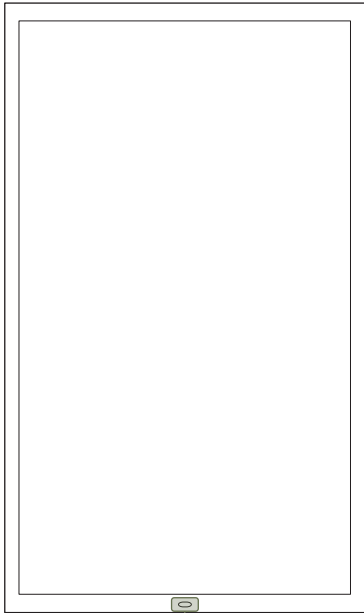

-  The colour and shape of parts may differ from what is shown. Specifications are subject to change without notice to improve quality.



Remote sensor

Parts	Description
Remote sensor	<p>Press a button on the remote control pointing at the sensor on the front of the product to perform the corresponding function.</p> <p> Using other display devices in the same space as the remote control of this product can cause the other display devices to be inadvertently controlled.</p>

Use the remote control within 2.5 m to 4 m from the sensor on the product at an angle of 30° from the left and right.



-  Store used batteries out of reach of children and recycle.
-  Do not use a new and used battery together. Replace both batteries at the same time.
-  Remove batteries when the remote control is not to be used for an extended period of time.

Ports

OH85N

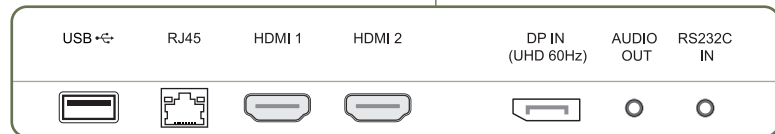
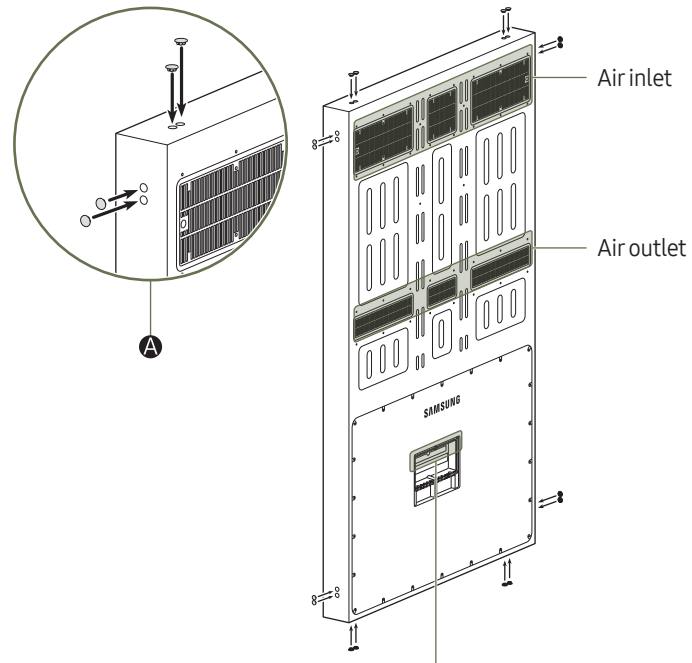
 The colour and shape of parts may differ from what is shown. Specifications are subject to change without notice to improve quality.







Port	Description
USB 	Connect to a USB memory device.
RJ45	Connects to MDC using a LAN cable. (10/100 Mbps)  Use Cat7(*STP Type) cable for the connection. *Shielded Twist Pair.
HDMI 1, HDMI 2	Connects to a source device using a HDMI cable or HDMI-DVI cable.
DP IN (UHD 60Hz)	Connects to a PC using a DP cable.  Obtain sharp picture quality when viewing UHD content at 60Hz.
AUDIO OUT	Outputs sound to an audio device via an audio cable.
RS232C IN	Connects to MDC using an RS232C adapter.

 **A**. Cover-cap locations

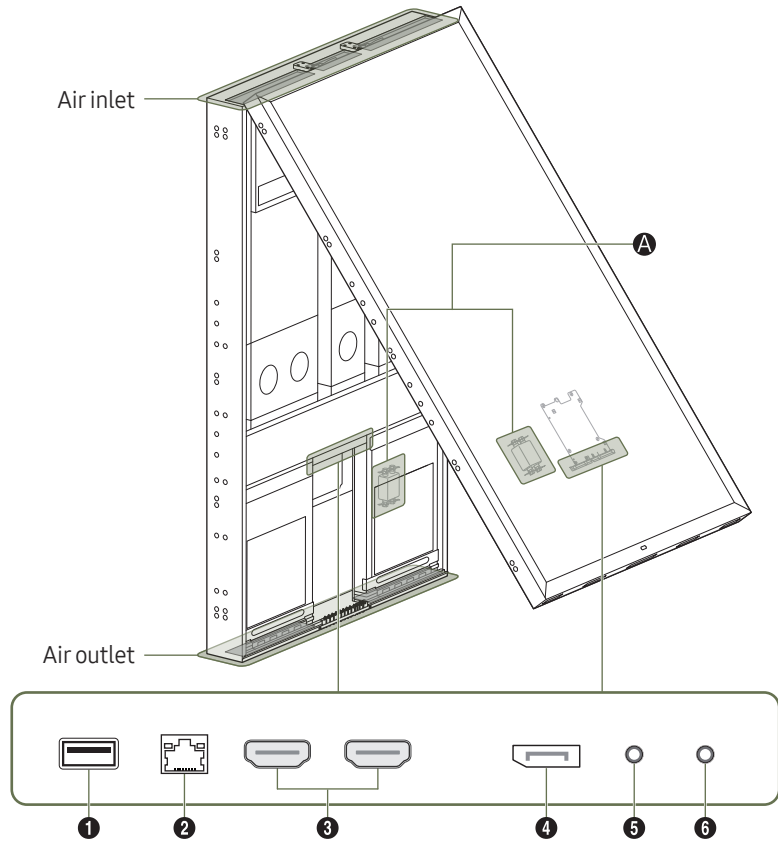
OH85N-DK

 The colour and shape of parts may differ from what is shown. Specifications are subject to change without notice to improve quality.



Port	Description
1 USB 	Connect to a USB memory device.
2 RJ45	Connects to MDC using a LAN cable. (10/100 Mbps)  Use Cat7(*STP Type) cable for the connection. *Shielded Twist Pair.
3 HDMI 1, HDMI 2	Connects to a source device using a HDMI cable or HDMI-DVI cable.
4 DP IN (UHD 60Hz)	Connects to a PC using a DP cable.  Obtain sharp picture quality when viewing UHD content at 60Hz.
5 AUDIO OUT	Outputs sound to an audio device via an audio cable.
6 RS232C IN	Connects to MDC using an RS232C adapter.

 A: Noise filter

 Warning: Do not touch this device and connected cables to avoid the risk of electrical shock.

Before Installing the Product (Installation Guide)

To prevent injury, this apparatus must be securely attached to the floor/wall in accordance with the installation instructions.

- Ensure that an authorised installation company installs the wall mount.
- Otherwise, it may fall and cause personal injury.
- Make sure to install the specified wall mount.

Rotation

 Supported model: OH85N

 Contact Samsung Customer Service Centre for further details.

- To use the product in Portrait mode, rotate clockwise until the power indicator (A) is positioned as shown in the images below.

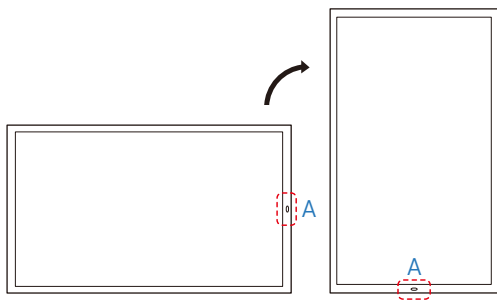

 Do not use this model installed on a ceiling, floor, or table.

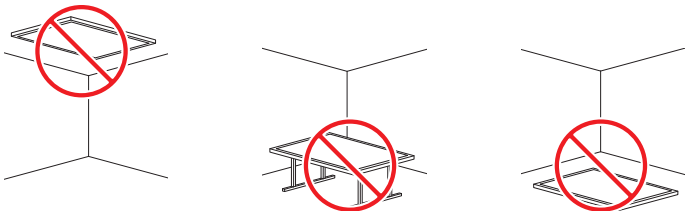

Ventilation

 Supported model: OH85N

 OH85N-DK is a double-sided display model. When installing the product, allow space of at least 200 mm from the ceiling and floor, and keep the ambient temperature below 50 °C.

 Contact Samsung Customer Service Centre for further details.

 For outdoor products, add a partition between the inlet and outlet to keep air paths separated.

Installation on a Perpendicular Wall

A Minimum 200 mm

B Ambient temperature: Under 50 °C

 When installing the product on a perpendicular wall, allow at least 200 mm of space between the product and wall surface for ventilation and ensure that the ambient A temperature is kept below 50 °C.

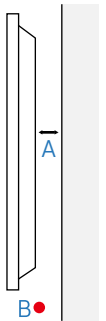

Installation on an Indented Wall

A Minimum 200 mm

B Ambient temperature: Under 50 °C

 When installing the product on an indented wall, allow at least the space specified above between the product and wall for ventilation and ensure that the ambient temperature is kept below 50 °C.

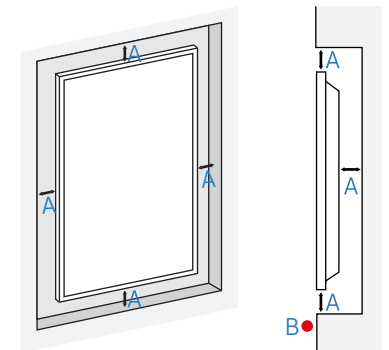

Before connecting cables

OH85N

 The colour and shape of parts may differ from what is shown. Specifications are subject to change without notice to improve quality.

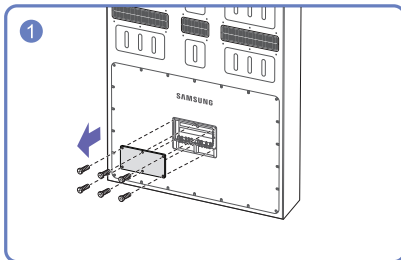

1 Unfasten the screws, then remove the cover.

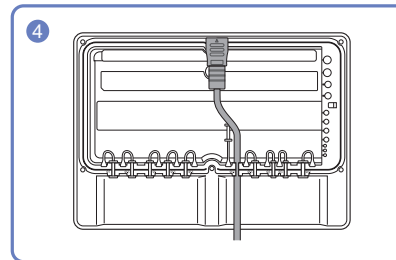



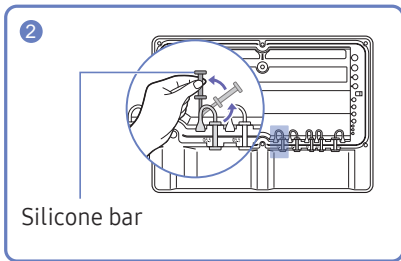

4 The cable should be connected as shown.



2 Remove the appropriate silicone bar for the thickness of the cable to connect.

Different hole sizes and corresponding cable thickness for each:

-  7 Ø hole x 1: Insert the 7 Ø cable
-  5.5 Ø hole x 6: Insert the 5.5 Ø cable
-  3 Ø hole x 2: Insert the 3 Ø cable
-  8.5 Ø hole x 1: Insert the 8.5 Ø cable

Silicone bar

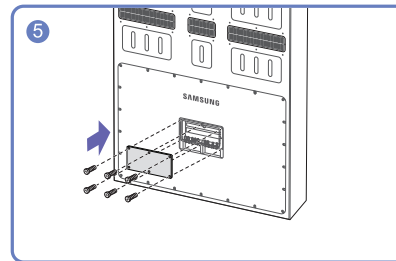

5 Close the cover, then fasten the screws.

 After all the cables are connected, make sure to close the cover and fasten the screws to ensure it is water tight.

 Recommended torque: 10 - 12 kgf.cm

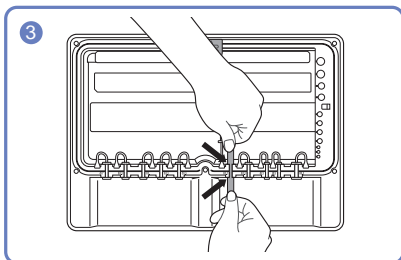

3 Insert the appropriate cable into the hole from which the silicone bar was removed.

OH85N-DK

 The colour and shape of parts may differ from what is shown. Specifications are subject to change without notice to improve quality.

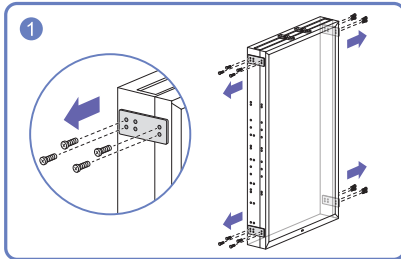

Remove screws from the brackets on both sides of the product.

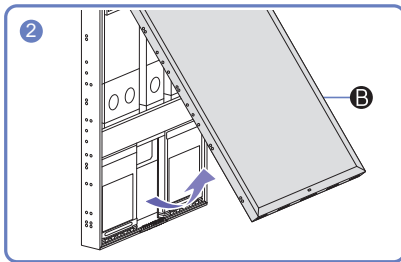

Open the auxiliary display (B).

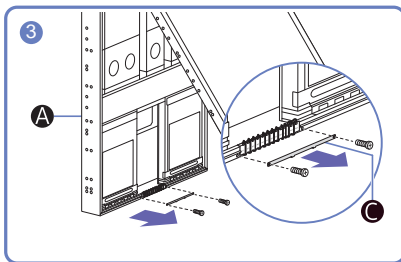

Remove the cable staple (C) at the bottom of the main display (A).

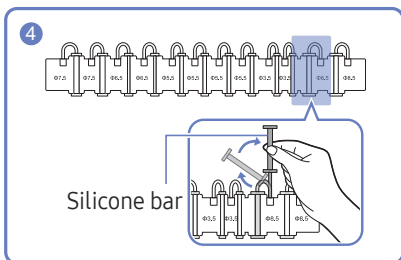

Remove the appropriate silicone bar for the thickness of the cable to connect.

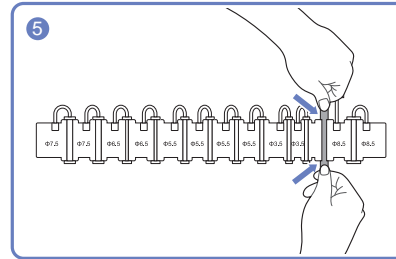

Insert the appropriate cable into the hole from which the silicone bar was removed.

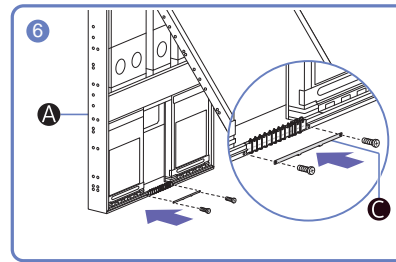

Once all cables are connected, place the cable staple (C) back to the bottom of the main display (A).

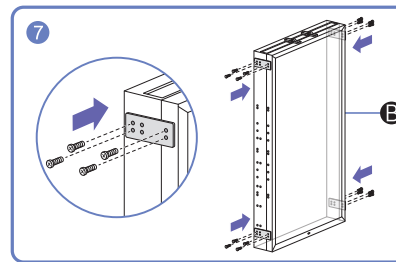

Close the auxiliary display (B) completely, then fasten the brackets on both sides of the product.

Power cable connection guide

 The colour and shape of parts may differ from what is shown. Specifications are subject to change without notice to improve quality.

OH85N

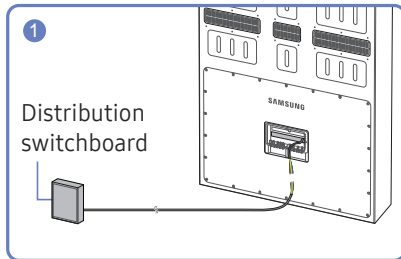

Make sure that you have a 8.5 mm diameter waterproof power cable that can withstand 1800 W or higher.

 The power cable must be connected to a 20 A or higher amperage circuit.

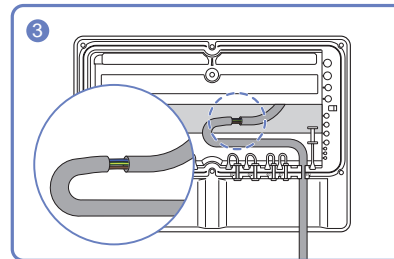

Put the soldered (connected) part of the power cables inside the product.

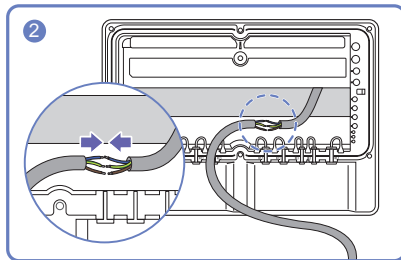

Connect the two power cables to each other. Solder and insulate the connected part.

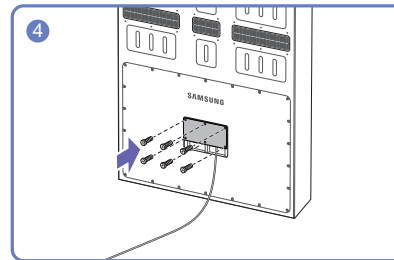

















Close the rear cover and fasten the screws.

Different power cable colours by country

When connecting an external power cable, be sure to match the colours of its wires with those of the 3 wires inside the product's power cable. The meaning (Neutral, Live or Ground) of each wire colour of the external power cable may differ depending on the country.

 Be sure to refer to the following table to correctly connect wires by the same meaning:

Neutral	Live	Ground	Country
BLUE 	BROWN 	GREEN/YELLOW 	Others
WHITE 	BLACK 	GREEN  or GREEN/YELLOW 	America
BLUE 	BROWN 	GREEN/YELLOW 	Europe
BLACK 	RED 	GREEN/YELLOW 	India
WHITE 	BLACK 	GREEN  or GREEN/YELLOW 	Taiwan & Japan

Wiring

 Supported model: OH85N-DK

- Use the enclosed clampers (D) to securely organise cables as shown in the below images.

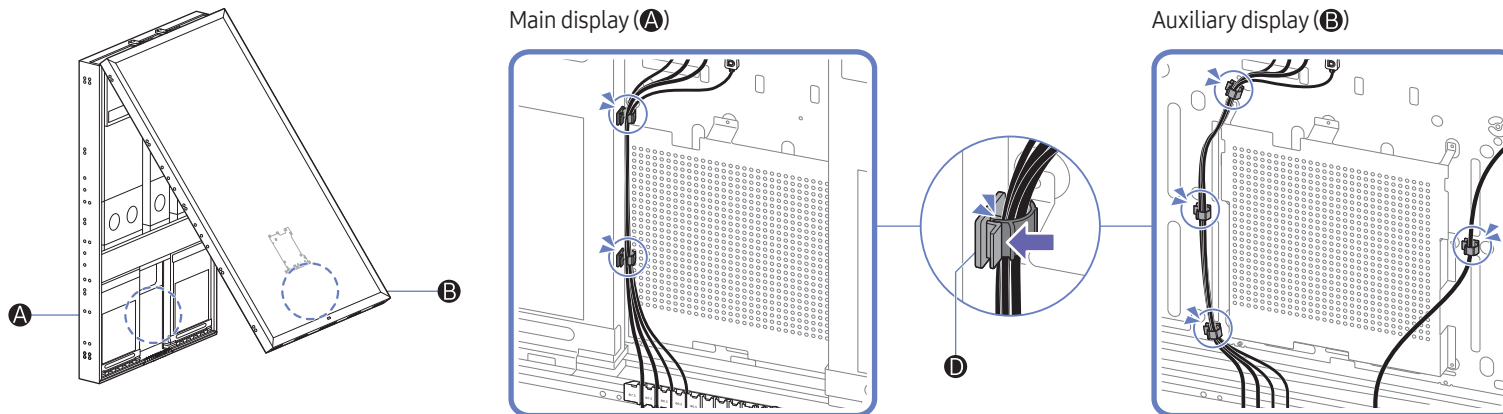

Wall Mount Specifications

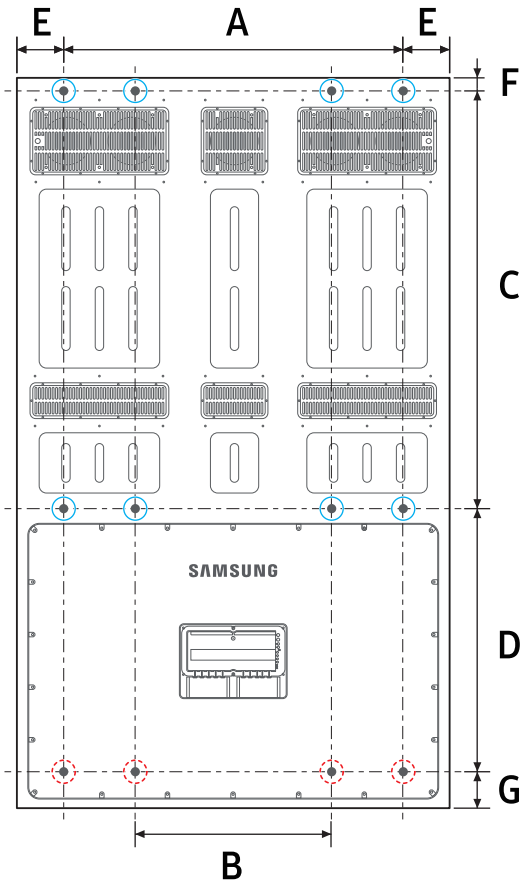

- Supported model: OH85N
- Install the wall mount on a solid wall that is perpendicular to the floor. If you install the product on a slanted wall, it may fall and result in severe personal injury.
Before attaching the wall mount to surfaces other than plaster board, please contact your nearest dealer for additional information.
- Do not use a wall mount that can tilt.
- Do not fasten the screws too firmly. This may damage the product or cause the product to fall, leading to personal injury. Samsung is not liable for these kinds of accidents.
- Do not keep the product turned on during the installation of the wall mount. It may result in personal injury due to electric shock.
- Do not use the guide holes for wall mounting.

Unit: mm

A	1000
B	500
C	1118.4
D	750
E	92.5
F	40.8
G	94.8
BOLT SIZE	M8

- Wall Mount Holes (8 Points)
- Guide Holes (4 Points) (Do not use the guide holes for wall mounting)

Chapter 02

Specifications

General

Model Name		OH85N / OH85N-DK
Panel	Size	85 CLASS (84.5 inches / 214.7 cm)
	Display area	1872 mm (H) x 1053 mm (V)
Power Supply		AC100-240V~ 50/60Hz Refer to the label at the back of the product as the standard voltage can vary in different countries.
Environmental considerations	Operating	Temperature: -30 °C – 50 °C (-22 °F – 122 °F) * Refer to Installation Guide for installation with an enclosure exposed to direct sunlight. Humidity: 10% – 80%, non-condensing
	Storage	Temperature: -20 °C – 50 °C (-4 °F – 122 °F) Humidity: 5% – 95%, non-condensing * Applicable before the product package is unpacked.

- ✎ **Plug-and-Play**
This monitor can be installed and used with any Plug-and-Play compatible systems. Two-way data exchange between the monitor and PC system optimises the monitor settings. Monitor installation takes place automatically. However, you can customise the installation settings if desired.
- ✎ Due to the nature of the manufacturing of this product, approximately 1 pixel per million (1ppm) may appear brighter or darker on the panel. This does not affect product performance.
- ✎ This is a class A product. In a domestic environment this product may cause radio interference in which case the user may be required to take adequate measures.
- ✎ For detailed device specifications, visit the Samsung Electronics website.

Preset Timing Modes

 This product can be set to only one resolution for each screen size to obtain the optimum picture quality due to the nature of the panel. Using a resolution other than the specified resolution may degrade the picture quality. To avoid this, it is recommended that you select the optimum resolution specified for your product.

Horizontal Frequency

The time required to scan a single line from the left to the right side of the screen is called a horizontal cycle. The reciprocal number of a horizontal cycle is called horizontal frequency. Horizontal frequency is measured in kHz.

Vertical Frequency

The product displays a single image multiple times per second (like a fluorescent light) to display what the viewer sees. The rate of a single image being displayed repeatedly per second is called vertical frequency or refresh rate. Vertical frequency is measured in Hz.

Model Name		OH85N / OH85N-DK
Synchronization	Horizontal Frequency	15 - 135 kHz (HDMI), 30 - 135 kHz (DP)
	Vertical Frequency	24 - 75 Hz (HDMI), 30 - 75 Hz (DP)
Resolution	Optimum resolution	3840 x 2160 @ 60 Hz
	Maximum resolution	3840 x 2160 @ 60 Hz

The screen will automatically be adjusted if a signal that belongs to the following standard signal modes is transmitted from your PC. If the signal transmitted from the PC does not belong to the standard signal modes, the screen may be blank with the power indicator on. In such a case, change the settings according to the following table by referring to the graphics card user manual.

Resolution	Horizontal Frequency (kHz)	Vertical Frequency (Hz)	Pixel Clock (MHz)	Sync Polarity (H/V)
IBM, 640 x 480	31.469	59.940	25.175	-/-
IBM, 720 x 400	31.469	70.087	28.322	-/+
MAC, 640 x 480	35.000	66.667	30.240	-/-
MAC, 832 x 624	49.726	74.551	57.284	-/-
MAC, 1152 x 870	68.681	75.062	100.000	-/-
VESA, 640 x 480	37.861	72.809	31.500	-/-
VESA, 640 x 480	37.500	75.000	31.500	-/-
VESA, 800 x 600	37.879	60.317	40.000	+/+
VESA, 800 x 600	48.077	72.188	50.000	+/+
VESA, 800 x 600	46.875	75.000	49.500	+/+
VESA, 1024 x 768	48.363	60.004	65.000	-/-
VESA, 1024 x 768	56.476	70.069	75.000	-/-
VESA, 1024 x 768	60.023	75.029	78.750	+/+
VESA, 1152 x 864	67.500	75.000	108.000	+/+
VESA, 1280 x 720	45.000	60.000	74.250	+/+
VESA, 1280 x 800	49.702	59.810	83.500	-/+
VESA, 1280 x 1024	63.981	60.020	108.000	+/+
VESA, 1280 x 1024	79.976	75.025	135.000	+/+

Resolution	Horizontal Frequency (kHz)	Vertical Frequency (Hz)	Pixel Clock (MHz)	Sync Polarity (H/V)
VESA, 1366 x 768	47.712	59.790	85.500	+/+
VESA, 1440 x 900	55.935	59.887	106.500	-/+
VESA, 1600 x 900	60.000	60.000	108.000	+/+
VESA, 1680 x 1050	65.290	59.954	146.250	-/+
VESA, 1920 x 1080	67.500	60.000	148.500	+/+
VESA, 2560 x 1440	88.787	59.951	241.500	+/-
CEA, 3840 x 2160 (HDMI)	135.000	60.000	148.500	+/+
VESA, 3840 x 2160 (DP)	133.313	59.997	533.250	+/-

Chapter 03

Appendix

Licence



Manufactured under license from Dolby Laboratories. Dolby, Dolby Audio, Pro Logic, and the double-D symbol are trademarks of Dolby Laboratories.



The terms HDMI and HDMI High-Definition Multimedia Interface, and the HDMI Logo are trademarks or registered trademarks of HDMI Licensing LLC in the United States and other countries.

Open Source Licence Notice

In the case of using open source software, Open Source Licences are available on the product menu. Open Source Licence Notice is written only English.

For information on the Open Source Licence Notice, contact the Samsung Customer centre or send email to oss.request@samsung.com.



THIS PRODUCT IS SOLD WITH A LIMITED LICENCE AND IS AUTHORISED TO BE USED ONLY IN CONNECTION WITH HEVC CONTENT THAT MEETS EACH OF THE THREE FOLLOWING QUALIFICATIONS: (1) HEVC CONTENT ONLY FOR PERSONAL USE; (2) HEVC CONTENT THAT IS NOT OFFERED FOR SALE; AND (3) HEVC CONTENT THAT IS CREATED BY THE OWNER OF THE PRODUCT.

THIS PRODUCT MAY NOT BE USED IN CONNECTION WITH HEVC ENCODED CONTENT CREATED BY A THIRD PARTY, WHICH THE USER HAS ORDERED OR PURCHASED FROM A THIRD PARTY, UNLESS THE USER IS SEPARATELY GRANTED RIGHTS TO USE THE PRODUCT WITH SUCH CONTENT BY A LICENSED SELLER OF THE CONTENT.

YOUR USE OF THIS PRODUCT IN CONNECTION WITH HEVC ENCODED CONTENT IS DEEMED ACCEPTANCE OF THE LIMITED AUTHORITY TO USE AS NOTED ABOVE.
